

D-Link®

DSC-350



1. Introduction

Thanks for purchasing the DSC-350 Dual Mode Camera. The User Guide contains information about installing and using the DSC-350 and using the TWAIN driver interface. This chapter introduces the basic functions of the DSC-350.

Refer to further chapters for information on installing and using the DSC-350.

Getting to Know the Digital Camera

The DSC-350 has all the features that you want in a digital camera and it's easy to install and use. Before using or connecting any of the components, please verify that all accessories are included.

The figures below show you the accessories names and positions.

Enclosed Accessories

1. DSC-350
2. TWAIN Driver in CD
3. 2xAAA Alkaline Battery
4. Camera Pouch
5. Hand Strap
6. Cradle
7. USB cable
8. Quick Start Guide
9. MGI Imaging software
10. User's manual

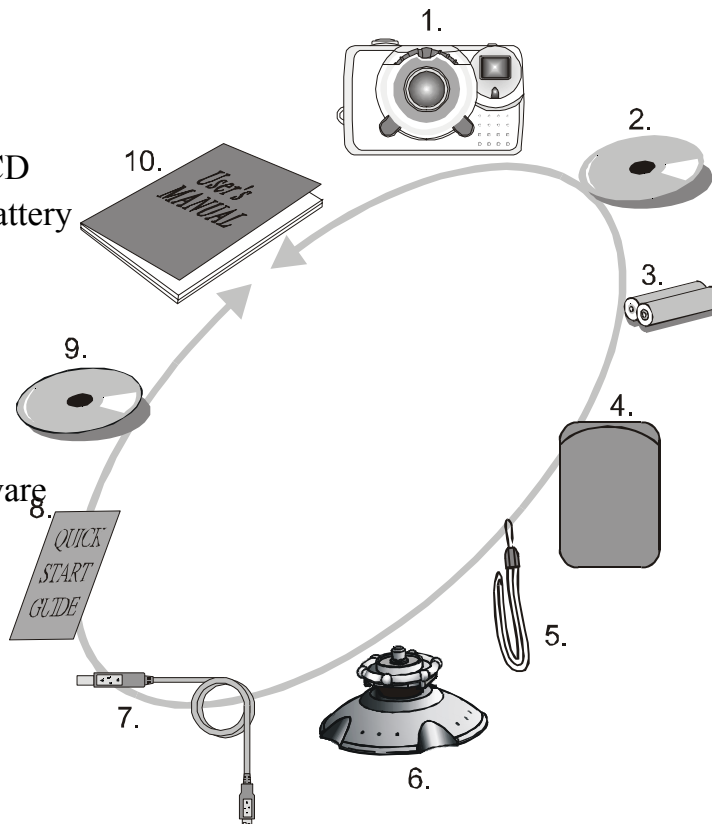

D-Link®

DSC-350



Front View

- Focus Ring
- View finder
- Lens
- LED light
- USB connector

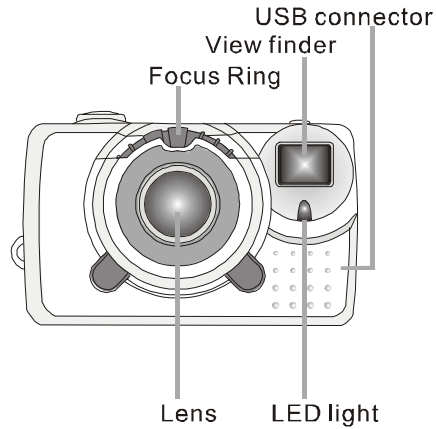

Rear View

- LED light
- View finder

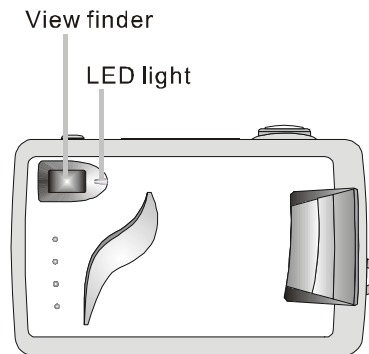

Top View

- Delete/Remain button
- Mode/Power button
- Shutter release button

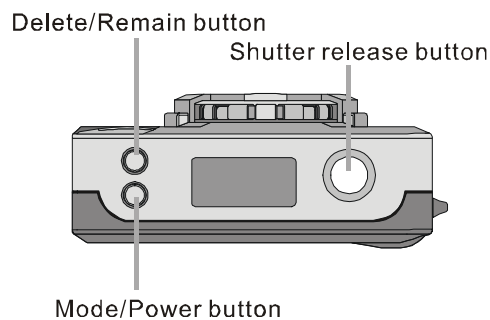

D-Link®

DSC-350



Bottom View

- Battery compartment
- Cradle hole or Tripod hole



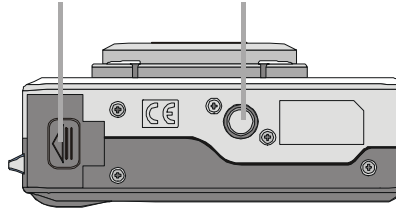



Battery compartment Cradle hole or Tripod hole



Indications Inside the Status LCD display



Status LCD Indicators

-  1. Single snap shot
-  2. Continuous snap shots (4 images)
-  3. Self timer
-  4. Video Recording
-  5. Frame rate
-  6. Photo number

D-Link®

DSC-350



7.REM% - Memory left (percentage)



8.BUSY - The image is being saved.



9.FULL - Memory is full.



10.Delete single picture



11. Delete all pictures.



12.USB connected sign



13.SHi - 1024x768 pixels resolution (interpolation)



14.HI - 640 x 480 pixels resolution



15.S - 320x 240 pixels resolution



16.Batteries are fully charged



17. Batteries are drained

2. Installing the DSC-350

System Requirements

To take advantage of the full-functionality of the DSC-350, your computer must meet or exceed the system requirements listed below:

IBM-PC/AT or compatible with USB port

D-Link®

DSC-350



- 1.OS Requirement: Windows 98/Me/2000 with 16MB RAM
- 2.VGA color display (TRUE color mode support is recommended)
- 3.TWAIN-compliant image application for PCs
- 4.CD-ROM and 3.5" floppy disk drive.
- 5.Available USB port for PCs

Installing the Batteries

The DSC-350 operates on 2 x AAA batteries.

1. Open the battery compartment cover.
2. Insert 2 AAA Alkaline batteries, making sure the battery polarity (+) and (-) is the way it is shown on the battery cover compartment.
3. Close the Battery compartment cover.

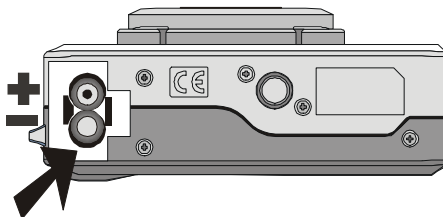

Install the TWAIN & Device Drivers

The TWAIN driver allows other applications to communicate with the DSC-350. You must install a TWAIN-compliant application (i.e. the bundled imaging software) before downloading pictures to your PC.

- (1) Turn on your computer
- (2) Insert the DSC-350 Driver CD into the CD-ROM
- (3) There are two ways to install the TWAIN & Device Drivers.

A. Autorun Program

You will see the drawing below while you insert the DSC-350 Driver CD into the CD-ROM. Just choose the suitable OS for your computer.

D-Link®

DSC-350



B. Manual

Click Start, then Run.



Type “**drive**:\win98\setup” if you are running Windows 98 or Windows Millenium Edition.

Type “**drive**:\win2000\setup” if you are running Windows 2000.

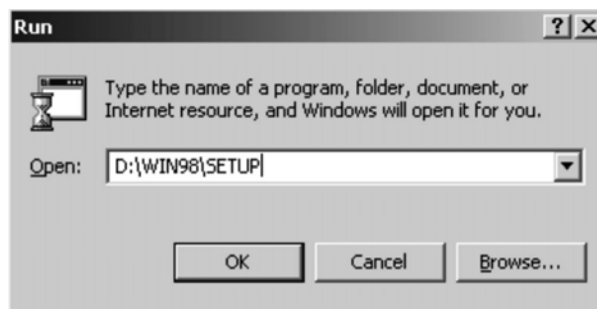

Replace **drive** with the letter of your CD-ROM.

Note: The first time you connect the DSC-350 to your computer while the computer is on, Windows will ask you for the Driver CD and the Windows Installation CD. Please have these ready before you

D-Link®

DSC-350



connect the DSC-350 to the USB port. When asked for the Driver CD, insert the Driver CD in your CD-ROM and type “*drive:*\win98” or “*drive:*\win2000” depending on what OS you are running (replace *drive* with your CD-ROM letter).

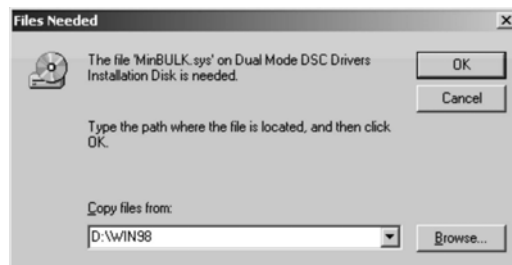

Connecting the Dual Mode Camera to a Computer

You can use the DSC-350 as a PC camera or retrieve/edit images stored in the built-in flash memory as a digital still camera.

To connect the camera to your computer:

1. Power the DSC-350 off.
2. Position your computer so that its USB ports can be accessed easily.
3. Connect the rectangular end of the USB cable to an available USB port on your computer.
4. Connect the other end of the USB cable to the USB connector of the DSC-350.
5. The camera is automatically powered on when it is plugged into the USB cable.

Note: All the function keys on the camera will be locked when the USB cable is plugged into the camera.

3. Using the DSC-350

Setting Camera

Shooting Modes









Press and hold “Mode/Power” button for 3 seconds to power on the camera,

D-Link®

DSC-350



and then press “MODE/Power” button to set the shooting modes. There are 5 shooting modes.

1. Single snap shot mode (): In Single snap shot mode, you take 1 picture every time you press the shutter release button.
2. Single snap shot with Self Timer mode ( ): Under this mode, the camera will take one picture 10 seconds after you press the shutter release button. The RED LED light will start to blink when you press the shutter button and stop blinking after 10 seconds. Please use a tripod or a steady support to hold the Camera.
3. Continuous snap shot mode ( ): The camera will take 4 images (1 image per second) after you press the shutter release button. The photo number will be counted from 4 to 1 while storing the images. The 4 images will be accounted in one photo only.
4. Continuous snap shot with self timer mode (  ): Under this mode, the camera will take 4 pictures in 10 seconds delay after you press the shutter release button. Please refer to the step of “single snap shot with self timer mode” to take pictures.
5. Video Recording (): The camera can take around 4 minutes of video recording with it’s built-in 8 MB flash memory. Press and hold shutter release button the camera will take a continuous video until you release the button. When making a video recording, the Red LED light in the front cover and Green LED light at the back cover will be blinking continuously.

Select resolutions

Snapshot

This dual mode camera has 3 different resolutions to choose when taking still images.

Press and hold the “Mode/Power” button first, and press shutter release button to switch to a different resolution.

“SHI” mode: Under this mode, the images taken are in 1024x768 pixels resolution (by software interpolation).

D-Link®

DSC-350



”HI” mode: The images taken are in 640x480 pixels resolution.

“S” mode: The pictures taken are in 320x240 pixels resolution.

Video Recording

You can choose between 2 resolutions when doing video recording. Use the same procedure to switch resolutions in video recording mode as you use in snapshot mode.

“S” mode: The video taken is in 320x240 pixels resolution.

The video taken is in 160x120 pixels resolution when there is no resolution indicator in the status LCD.

Taking Pictures

(DSC-350 Digital Camera and Video Camera)

When taking still images or video recording: MAKE SURE THE DSC-350 is POWERED ON and SET AT THE MODE YOU NEED. Make sure you are able to locate the object you want to shoot through the view-finder.

Note:

1. In order to save power, the camera will automatically power off if you don't use the camera for 1 minute. Power on the camera again, if you want to take pictures/video again.
2. You can check the memory left by holding “Delete/Remain“ button. The LED display shows the percentage of memory left ($\frac{199}{\text{REM}\%}$) when you press and hold “Delete/Remain” button.

1. Digital Still Camera

- (1) Press the “Mode/Power” button for 3 seconds to power on.
- (2) Choose DSC mode and setting resolution.
- (3) Use the Viewfinder to locate the object.

D-Link®

DSC-350



- (4) Press the shutter release button for taking pictures. The DSC-350 takes approximately 1 second to save the image. When the green LED light stops blinking and the "BUSY" indicator disappear in the status LCD, the image saving is done and the DSC-350 ready for next shot.

*Note: The focus range is from approximately 1.5 inch (4cm) to infinity.
Please refer to the following chart to set the focus.*

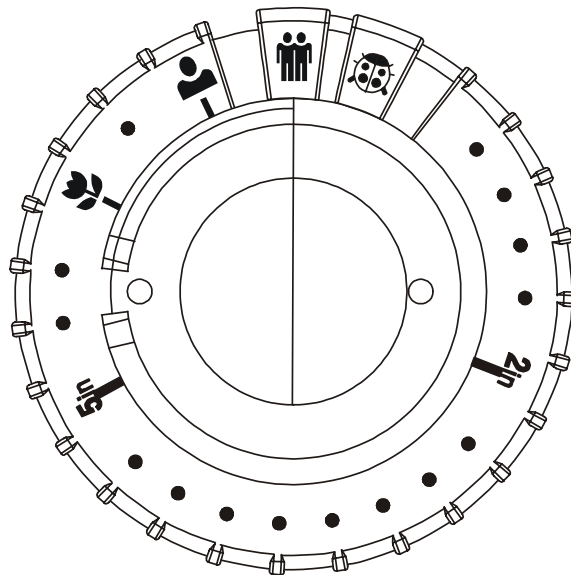

- 60 inch (1.5M) ~ infinity.



- Around 20 inch (50 CM).



- Around 10 inch (25 CM).



- Around 5 inch (12 CM).



- Around 2 inch (6 CM).



- Around 1.5 inch (4 CM).

D-Link®

DSC-350



2. Video Recording



- (5) Press the “Mode/Power” button for 3 seconds to power on.
- (6) Choose video recording mode and set the resolution (refer to setting camera).
- (7) Set the focus ring at right position. (refer to the data at focus ring)
- (8) Use the viewfinder to locate the object. Press and hold the shutter release button to begin taking a video recording. The camera will take a continuous video until you release the shutter button.

Note: Please set the focus ring at “” position for normal using purpose (focus range from 60 inch ~ infinity).

3. PC camera function

- (9) Power off your DSC-350.
- (10) Connect your DSC-350 to your PC. The DSC-350 camera will automatically power on and switch to PC camera function.
- (11) Choose MGI Imaging Software.
- (12) Adjust the focus ring to have clear images. The focus range is from 1.5 inch (4 cm) approximately to infinity.

Delete Pictures

1. Delete single picture ”  ”: Press “Delete/Remain” button and delete indicator will appear on status LCD. Then press the shutter release button. The last picture will be deleted.
2. Delete all pictures “  ”: Press “Delete/Remain” button twice, the delete all indicator will appear on the status LCD. Then press shutter release button to erase all the pictures.

Note: Delete single/all pictures can also be done using the Twain interface when downloading images to your PC.

D-Link®

DSC-350



4. Using the TWAIN Driver Interface

Getting to Know the TWAIN Interface

The DSC-350 ship with a user-friendly software for the TWAIN interface. You can use the software that comes bundled with the DSC-350 to download the pictures that you take with the DSC-350 TWAIN is an industry standard interface for scanners and digital cameras. The TWAIN Interface works in combination with any TWAIN compliant image processing application, such as MGI PhotoSuite III. The image processing application is often referred to as the host application.

Transferring images to your computer

The following illustration provides an overview of the TWAIN Interface to download photographs from your camera to your computer. We use MGI PhotoSuite III as our TWAIN compliant image processing application.

1. Execute the TWAIN compliant image processing application :
MGIPhotoSuite III.
2. Select TWAIN Source.



D-Link®

DSC-350

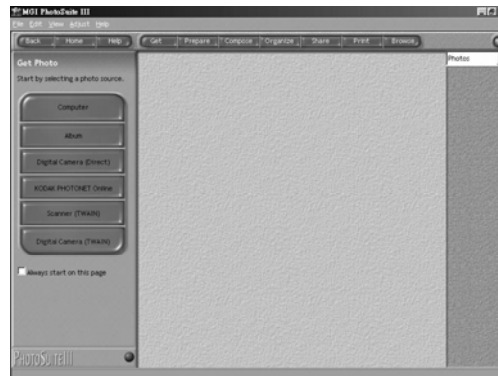

3. Choose D-Link DSC-350

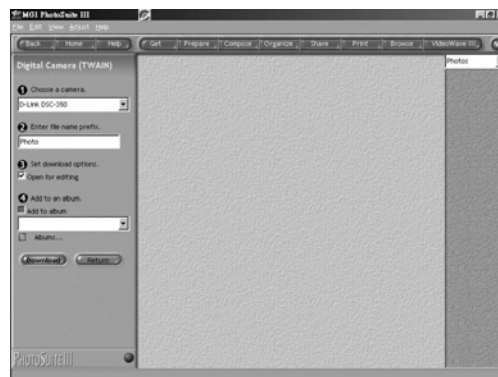

Note: You need to select the Source just one time (Step 2 and Step 3) after you install the TWAIN Driver.

4. Acquire: Push “Download” button.

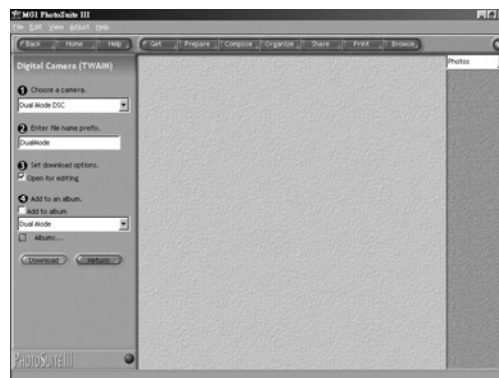

4.1 Retrieving thumbnail

D-Link®

DSC-350

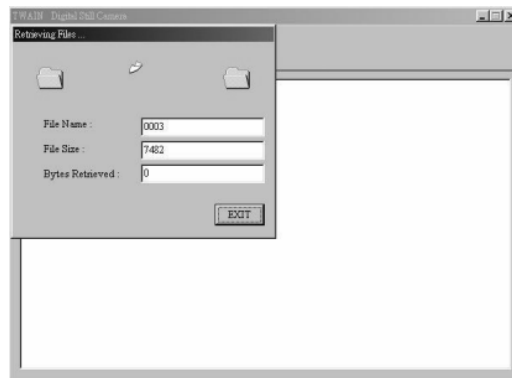

4.2 Thumbnail: After acquire, you will get the thumbnails of your pictures.

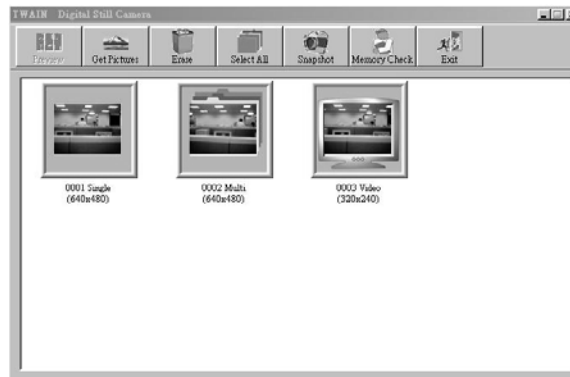

5. If a Can NOT find your Digital Still Camera error appears: Please check your USB connection and push the OK and Preview buttons to try again.



6. GET Pictures: Please select the picture you want, and then click

D-Link®

DSC-350



“get pictures”.

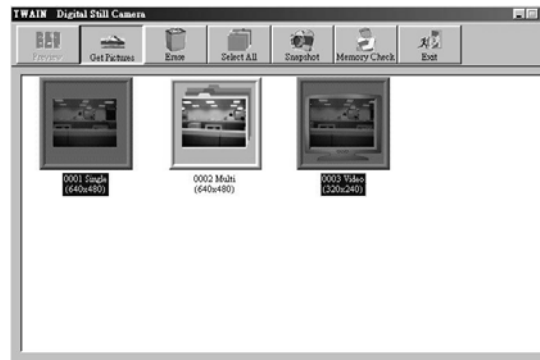

6.1 Open pictures

If you want to view the full-size picture before saving it to disk, select the “Open Pictures”

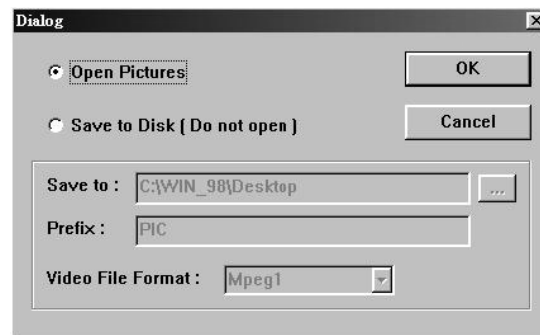

6.2 After you press the OK button, the full size picture will be retrieved and the thumbnail window will be closed.

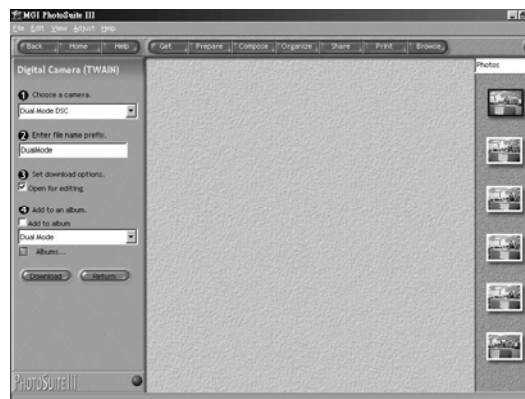

6.3 Save to disk [Do not open]

D-Link®

DSC-350



If you want to save the pictures to disk directly please select the “Save to Disk [Do not open]”.

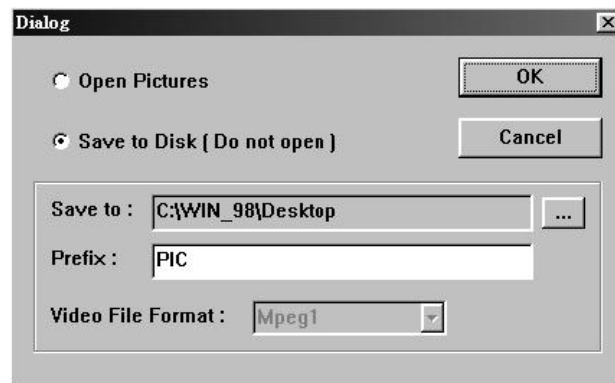

You can select your favorite directory to save the pictures, just pushing the browse button “...”.

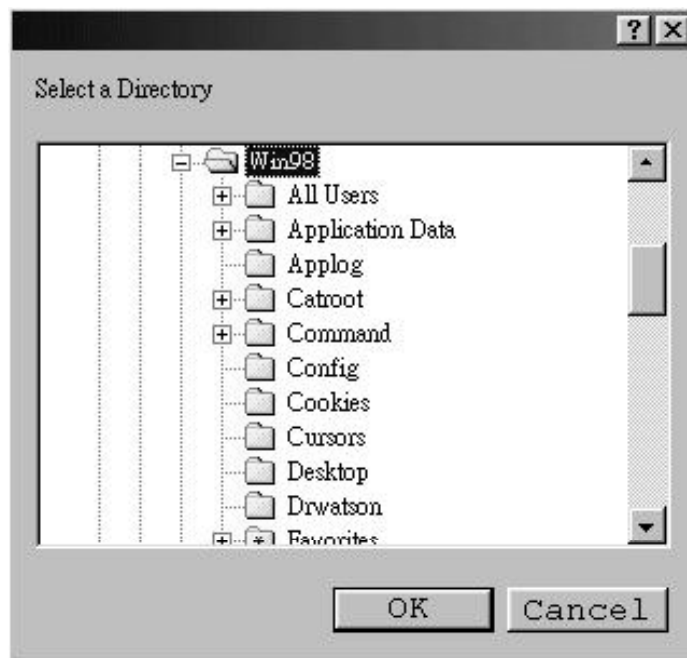

The prefix will become the first part of the pictures' file names. For example, if you select pictures 0001, 0003 and 0010 to save to disk, and the prefix is “Pic”. Then the pictures' file names will be Pic0001.jpg, Pic0003.jpg and Pic0010.jpg. A special case is that if there is a file named Pic0001.jpg in the directory already, the new downloaded picture 0001 will

D-Link®

DSC-350



be saved as Pic0001-1.jpg, automatically.

In video file format, You can choose AVI or Mpeg1 file format. AVI file has large file size but short image processing time. Mpeg1 file has small file size but long image processing time.

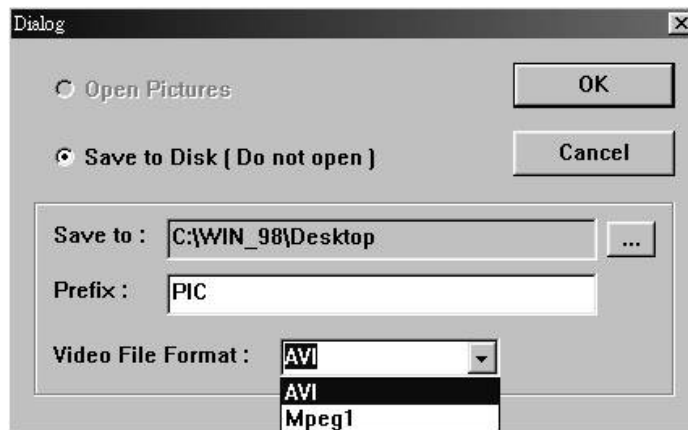

7. Erasing pictures: Select the pictures you want to erase and click on the “ERASE” button.

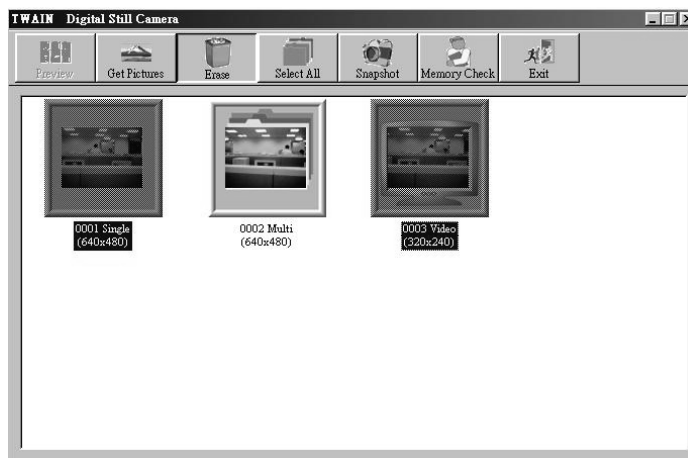

Note: The images stored in the camera will be erased when you click the erase button. Make sure you want to delete the photos before clicking the “ERASE” button.

After erasing

D-Link®

DSC-350

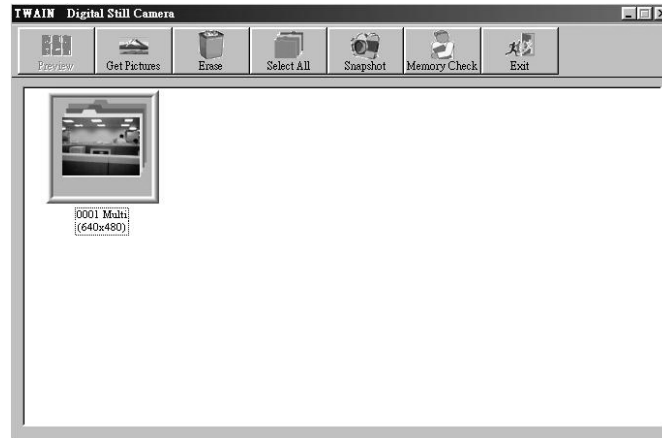

8. Snapshot:

Push the “Snapshot” button, and you can take a picture on line



9. Memory Check:

Push Press the “Memory Check” button to check the memory in your DSC-350.

Warning:

Memory check will destroy all photos.

Memory Check ” will take a while. When it is processing, please DO NOT abort it.

D-Link®

DSC-350

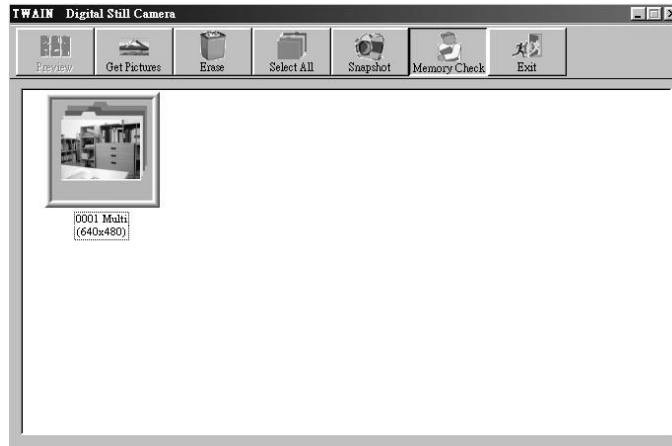

After Memory Check:

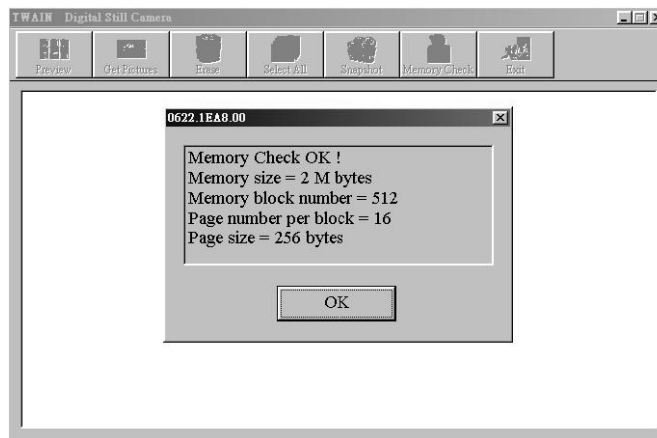

10. Congratulations! Now you can manage, enhance and edit your photographs as you want.

5. DSC-350 Camera Specifications

D-Link®

DSC-350



DSC-350 Camera	
Image devices	350k pixel CMOS sensor
Resolution	1024x768 pixel, 640x480 pixel, 320x240 pixel,
Color depth	24 bit true color
Auto exposure	Yes
Cxposure/Iris Control-iso rating	100
White balance	Auto
Shutter speed	1/4 ~1/2000
view finder	Aes
Status lcd	Aes
Self timer	10 secs
Lens	manual focus-340 degree manual adjustable (f=7.1mm, equivalent to 46.7mm lens on a 35mm camera)
Focus Range	Around 1.5 inch (4 cm)~infinity
Aperture	2,2/5,6 (auto switch)
Consecutive shots	4 image, 1 image/scond
Format	JPEG
Recording Media	8MB flash memory
Delete Picture	Yes (All /Single)
PC Camera	
Max. frame/sec	30 fps@VGA
VIDEO Recording	
Recording Time	QVGA (320x240):4 fps/5 minutes. (160x120):20 fps/5 minutes.
Dateifformat	Avi (Video for Windows) Mpeg 1
Battery	2xAAA Alkaline battery
Interface	USB
Dimension(WxHxD)mm	96mm(W) x 58mm(H) x 31mm(D)
Weight(without Battery)	Around110g
Power Consumption	Max. 1W

“Specification and product design are subject to change without any notice for further improvement”